



User Manual

BSM48212W Unit

Content

1. Introduction	3
1.1 Important Safety Instructions	3
1.2 Brief Introduction	4
1.3 Product Properties	4
2. Product Specification	5
2.1 Size and Weight	5
2.2 Performance Parameter	5
2.3 Equipment Interface Instruction	6
2.4 Battery Management System(BMS)	8
2.4.1 BMS Protection and Alarm	8
3. Installation and Configuration	9
3.1 Preparation for installation	9
3.1.1 Safety Requirement	9
3.1.2 Environmental requirements	9
3.1.3 Tools and data	10
3.1.4 Technical preparation	10
3.1.5 Unpacking inspection	10
3.2 Equipment installation	11
3.2.1 Installation Steps	11
4. Bluetooth Introduction	14
5. Operating System Description	14
5.1 Battery system usage and operation instructions	14
5.2 Alarm description and processing	15

1. Introduction

1.1 Important Safety Instructions



Danger!

- Please do not put the battery into water or fire, in case of explosion or any other situation that might endanger your life.
- Please connect wires properly while installation, do not reverse connect. To avoid short circuit, please do not connect positive and negative poles with conductor on the same device.
- Please avoid any form of damage to battery, especially stab, hit, trample or strike.



Danger!

- Please shut off the power completely when removing the device or reconnecting wires during the daily use or it could cause the danger of electric shock.
- Please use dry powder extinguisher to put out the flame when encountering a fire hazard, liquid extinguisher could result in the risk of explosion.
- For your safety, please do not arbitrarily dismantle any component in any circumstances. The maintenance must be implemented by authorized technical personnel or our company's technical support. Device breakdown due to unauthorized operation will not be covered under warranty.



Caution!

- Our products have been strictly inspected before shipment. Please contact us if you find any abnormal phenomena such as device outer case bulging.
- The product shall be grounded properly before use in order to ensure your safety.
- To assure the proper use please make sure parameters among the relevant device are compatible and matched.
- Please do not mixed-use batteries from different manufacturers, different types and models, as well as old and new together.



Caution!

- Ambient and storage method could impact the product life span, please comply with the operation environment instruction to ensure device works in proper condition.
- For long-term storage, the battery should be recharged once every 6 months, and the amount of electric charge shall exceed 80% of the rated capacity.
- Please charge the battery in 18 hours after it fully discharged or over-discharging protection mode is activated.
- Formula of theoretical standby time: $T=C/I$ (T is standby time, C is battery capacity, I is total current of all loads).

1.2 Brief Introduction

BSM48212W lithium iron phosphate battery system is a standard battery system unit, customers can choose a certain number of BSM48212W according to their needs, by connecting parallel to form a larger capacity battery pack, to meet the user's long-term power supply needs. The product is especially suitable for energy storage applications with high operating temperatures, limited installation space, long power backup time and long service life.

1.3 Product Properties

BSM48212W energy storage product's positive electrode materials are lithium iron phosphate, battery cells are managed effectively by BMS with better performance, the system's features as below:

- The whole module is non-toxic, non-polluting and environmentally friendly;
- Cathode material is made from LiFePO₄ with safety performance and long cycle life
- Battery management system with better performance, possesses protection function like over-discharge, over-charge, over-current, abnormal temperature.
- Self-management on charging and discharging, Single core balancing function.
Intelligent design configures integrated inspection module.
- Flexible configuration, multiple battery modules can be in parallel for expanding capacity and power.
- Flexible configurations allow parallel of multi battery for longer standby time.
Self-ventilation with lower system noise.
- Less battery self-discharge, then recharging period can be up to 10 months during the storage.
- No memory effect so that battery can be charged and discharged shallowly.
- With wide range of temperature for working environment, -10°C ~ +50°C, circulation span and discharging performance are well under high temperature.
- Small size and light weight, standard designed module is comfortable for installation and maintenance;

2. Product Specification

2.1 Size and Weight

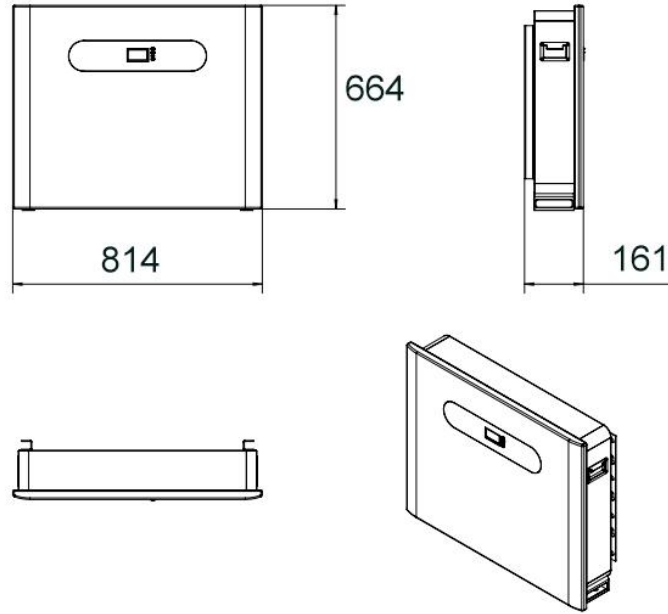

Table 2-1 BSM48212W Device size

Product	Nominal Voltage(V)	Nominal Capacity(Ah)	Dimension(mm)	Weight(Kg)
BSM48212W	DC 51.2	212	814*664*161	95.1

2.2 Performance Parameter

Table 2-2 BSM48212W performance parameter

Basic Parameters	BSM48212W
Nominal Voltage (V)	51.2
Nominal Capacity (KWH)	10.84
Usable Capacity (KWH)	9.76
Discharge Voltage (V)	40
Charge Voltage (V)	58.4
Recommend Charge/Discharge Current (A)	140
Max. Charge/Discharge Current(A)	200
Peak Charge/Discharge Current(A)	240(15S)
Communicaiton	RS485/CAN
Working Temperature	0°C~50°C Charge ; -10°C ~50°C Discharge
Shelf Temperature	-20°C~60°C
Certification	CE/IEC/UL/UN38.3/MSDS
Design Life	10 years+
Cycle Life	>6000

2.3 Equipment Interface Instruction

This section details the front and back interface functions of the BSM48212W pack

BSM48212W Product Front Interface

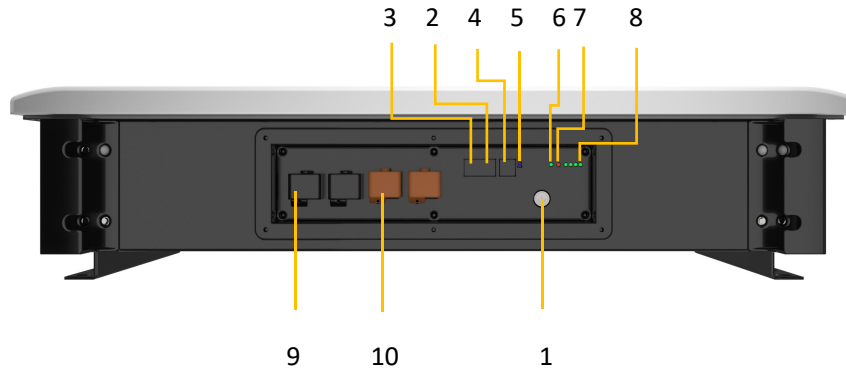
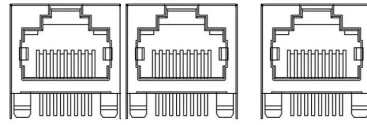
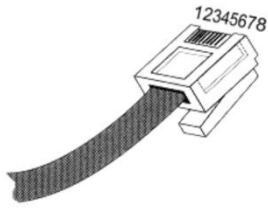

Table 2-3 Interface Definition

Item	Name	Definition
1	ON/OFF	Battery start
2	RS4851	Battery Parallel communication
3	RS4852	Battery Parallel communication
4	RS485/CAN	Communication to inverter
5	Reset	Reset BMS
6	Run	Running light
7	Alm	Alarm light
8	SOC	SOC light
9	Negative socket	Battery output negative or parallel negative line
10	Positive socket	Battery output positive or parallel positive line







2.3.2 CAN/485 interface definition



RS4851	RS4852	RS485/CAN
For pack parallel		For inverter

	PIN position	Color	Definition
RS4851/RS4852	PIN1	Orange/White	485B1
	PIN2	Orange	485A1
	PIN3	Green/White	GND
	PIN4	Blue	NC
	PIN5	Blue/White	NC
	PIN6	Green	GND
	PIN7	Brown/White	485A1
	PIN8	Brown	485B1
RS485/CAN	PIN1	Orange/White	485B1
	PIN2	Orange	485A1
	PIN3	Green/White	NC
	PIN4	Blue	CANH
	PIN5	Blue/White	CANL
	PIN6	Green	NC
	PIN7	Brown/White	485A1
	PIN8	Brown	485B1

2.3.4 LED status indicator

Battery Status	Normal/ ALM/ Protection	RUN	ALM	SOC				Remark
								
Shutdown	Sleep	OFF	OFF	OFF	OFF	OFF	OFF	
Standby	Normal	FLASH1	OFF					
	ALM	FLASH1	FLASH3					
Charge	Normal	ON	OFF					
	ALM	ON	FLASH3					
	Protection	ON						
	Protection	OFF						
	Normal	FLASH3						

Discharge	ALM	FLASH3			
	Protection	OFF			
	Protection	OFF			
Invalid		OFF			

2.4 Battery Management System(BMS)

2.4.1 BMS Protection and Alarm

Over Voltage Alarm/Protection in Charging:

When total voltage or any battery cell voltage reaches the rated alarm value during charging stage, the alarm light will flash. When reaches the rated protection value, the alarm light will on, battery will stop charge. After total voltage or all cell voltage back to rated range, the protection is over

Low Voltage Protection in Discharging:

Battery system will stop supply power to the outside, when any battery cell voltage or total voltage is lower than the rated protection value during discharging, the over-discharging protection is activated. When the voltage of each cell back to rated return range, the protection is over.

Over Current Protection in Charging:

When the charge current $> 200A$, current limit protection mode is activated, current will be limited to 20A, protection is removed after rated time delaying 10S. Circulate like this until the current is lower than 200A.

Over Current Protection in Discharging:

When the discharge current is higher than 200A, the battery buzzer alarms and the system stops discharging after 15s. After protection, the discharging will restore in 60s delay or immediately when there is charging current.

Low/Over temperature protection in charging:

When battery's temperature is beyond range of $0^{\circ}C \sim +55^{\circ}C$ during charging, temperature protection is activated, device stops charging.

The protection is over when temperature back to rated working range.

Low/Over temperature protection in discharging:

When battery's temperature is beyond range of $-10^{\circ}C \sim +55^{\circ}C$ during discharging, temperature protection is activated, device stops supplying power to the outside.

The protection is over when temperature back to rated working range.

Short Circuit Protection:

When the battery is activated from the shutdown state, if a short circuit occurs, the system starts short-circuit protection for 60 seconds.

Self-Shutdown:

When device connects no external loads and power supply and no external communication for over 72 hours, device will dormant standby automatically.

3. Installation and Configuration



3.1 Preparation for installation

3.1.1 Safety Requirement

This system can only be installed by personnel who have been trained in the power supply system and have sufficient knowledge of the power system.

The safety regulations and local safety regulations listed below should always be followed during the installation.

- All circuits connected to this power system with an external voltage of less than 51.2V must meet the SELV requirements defined in the IEC60950 standard.
- If operating within the power system cabinet, make sure the power system is not charged. Battery devices should also be switched off.
- Distribution cable wiring should be reasonable and has the protective measures to avoid touching these cables while operating power equipment.
- when installing the battery system, must wear the protective items below:

		
<p>The isolation gloves</p>	<p>Safety goggles</p>	<p>Safety shoes</p>

3.1.2 Environmental requirements

Working temperature: -10°C ~ +50°C

Charging temperature range is 0°C~+50°C,

Discharging temperature range is -10°C ~+50°C

Storage temperature: -20°C~ +60°C

Relative humidity: 5% ~ 85%RH

Elevation: no more than 4000m

Operating environment: Indoor installation, sites avoid the sun and no wind, no conductive dust and corrosive gas.

And the following conditions are met:

- Installation location should be away from the sea to avoid brine and high humidity environment.
- The ground for product arrangement shall be flat and level.

- No flammable explosive materials near the installation site.
- The optimal ambient temperature is 15 °C~ 30 °C
- Keep away from dust and messy zones

3.1.3 Tools and data

Tools and meters that may be used are shown in table 3-1.

Table 3-1 Tool instrument

NAME	
Screwdriver (Slotted、Phillips)	Multimeter
Torque wrench	Clamp current meter
Diagonal pliers	Insulation tape
Pointed nose pliers	Temperature meter
Pliers to hold the wire	Anti-static bracelet
Stripping pliers	Cable tie
Electric drill	Tape measure

3.1.4 Technical preparation

Electrical interface check

Devices that can be connected directly to the battery can be user equipment, power supplies, or other power supplies.

- Confirm whether the user's PV power generation equipment, power supply or other power supply equipment has a DC output interface, and measure whether the DC power output voltage meets the voltage range requirements in Table 2-2.
- Confirm that the maximum discharge current capability of the DC power interface of the user's photovoltaic power generation equipment, power supply or other power supply equipment should be higher than the maximum charging current of the products used in Table 2-2.

If the maximum discharge capacity of the DC power interface of the user's photovoltaic power generation equipment is less than the maximum charging current of the products used in Table 2-2, the DC power interface of the user's photovoltaic power generation equipment shall have a current limiting function to ensure the normal operation of the user's equipment.

- Verify that the maximum operating current of the battery-powered user equipment (inverter DC input) should be less than the maximum discharge current of the products used in Table 2-2.

The security check

- Firefighting equipment should be provided near the product, such as portable dry powder fire extinguisher.
- Automatic fire fighting system shall be provided for the case where necessary.
- No flammable, explosive and other dangerous materials are placed beside the battery.

3.1.5 Unpacking inspection

- When the equipment arrives at the installation site, loading and unloading should be carried out according to the rules and regulations, to prevent from being exposed to

sun and rain.

- Before unpacking, the total number of packages shall be indicated according to the shipping list attached to each package, and the case shall be checked for good condition.
- In the process of unpacking, handle with care and protect the surface coating of the object.
- Open the package, the installation personnel should read the technical documents, verify the list, according to the configuration table and packing list, ensure objects are complete and intact, if the internal packing is damaged, should be examined and recorded in detail.

Packing list is as follows:

Item	Specification	Quantity	Figure
Battery-BSM48212W	51.2V/200AH	1	
Ground Wire	L500mm/4mm ²	1	
User Manual		1	

3.2 Equipment installation

3.2.1 Installation Steps

Step 1 Mechanical Installation

(1) Installation on the wall:

1. Install hole prepare

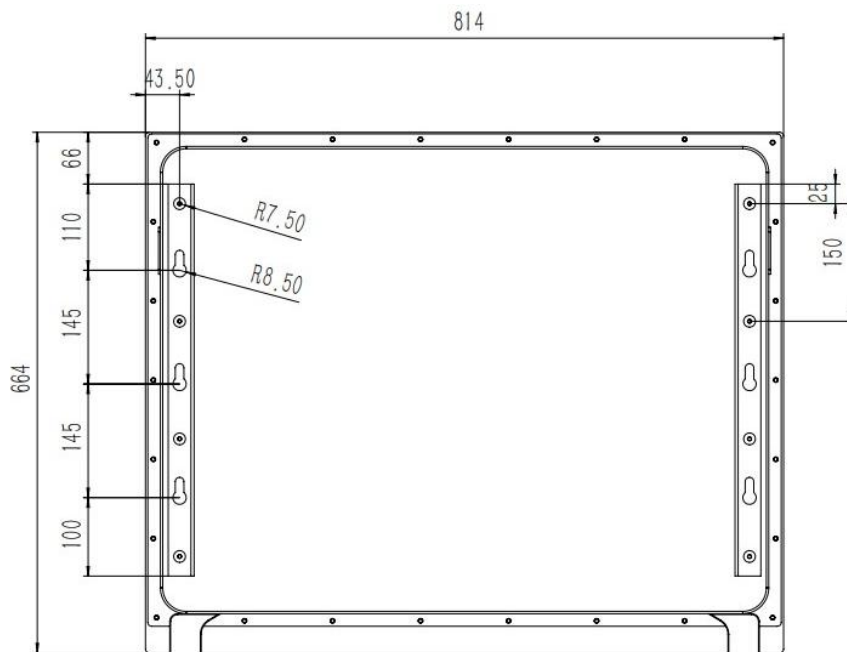

2. On the wall install



Step 2 Electrical installation

- (1) Connect with inverter power single

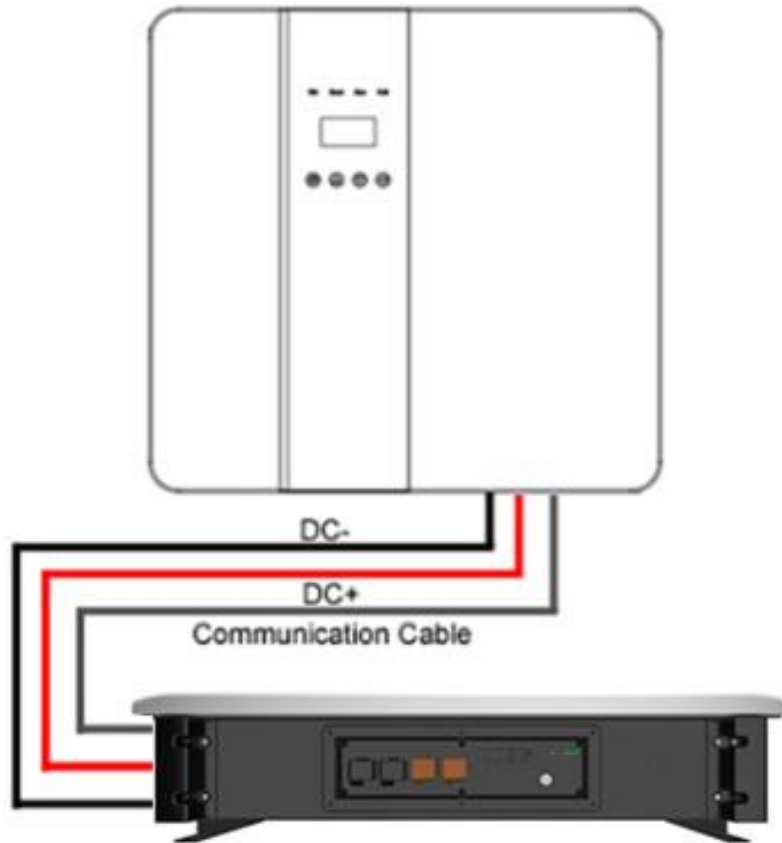

3.2.2 Battery parameter settings on the inverter

If your inverter do not have communication function with BSM48212WW battery pack, please set inverter follow next data.

Max Charging(Bulk) Voltage: 57V

Absorption Voltage: 56.5V

Float Voltage: 56V

Shut Down(cut off) Voltage: 49V

Shut Down(cut off) SOC: 20%

Restart Voltage: 51.2V

Max Charge Current: 200A*battery QTY

Max Discharge Current: 200A*battery QTY

4. Bluetooth Introduction

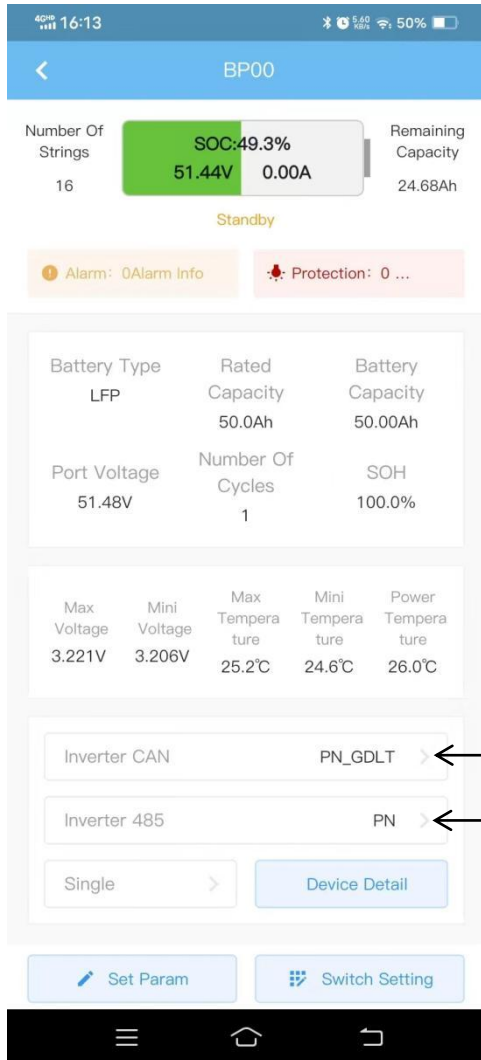

APP download
(Detailed information check the Bluetooth introduction document)

5. Operating System Description

5.1 Battery system usage and operation instructions

After completing the electrical installation, follow these steps to start the battery system.

1. Press the ON/OFF button to the ON position.
2. After the indicator self-test, the RUN indicator will light and the SOC indicator will be on (50% SOC status in the 2.3.4).



1. After pressing the power button, if the battery status indicator on the front panel continues to be red, please refer to the "4.2 Alarm description and processing ". If the failure cannot be eliminated, please contact the dealer timely.
2. Use a voltmeter to measure whether the voltage of the circuit breaker battery access terminal is higher than 48V, and check whether the voltage polarity is consistent with the inverter input polarity. If the circuit breaker battery input terminal has a voltage output and is greater than 48V, then the battery begun to work normally.
3. After confirming that the battery output voltage and polarity are correct, turn on the inverter, close the circuit breaker.
4. Check if the indicator of the inverter and battery connection (communication indicator and battery access status indicator) is normal. If it is normal, successfully complete the connection between the battery and the inverter. If the indicator light is abnormal, please refer to the inverter manual for the cause

If the fault such as single cell over voltage, charging over-current, under-voltage protection, high-temp protection and other abnormalities which affects the output, please deal with it according to Table 4-1.

Table 4-1 Main alarm and Protection

Statue	Alarm category	Alarm indication	Processing
Charge state	Over-current	RED	Stop charging and find out the cause of the trouble
	High temp	Red	Stop charging
Discharge state	Over-current	Red	Stop discharging and find out the cause of the trouble
	High temp	Red	Stop discharging and find out the cause of the trouble
	Total voltage undervoltage	Red	Start charging
	Cell voltage undervoltage	Red	Start charging

5.2 Analysis and treatment of common faults

Analysis and treatment of common faults in the Table 4-2:

Table 4-2 Analysis and treatment of common faults

No.	Fault phenomenon	Reason analysis	Solution
1	The indicator does not respond after the power on Total voltage lower than 40V Check	Total voltage lower than 40V	Check the total voltage

	the total voltage		
2	No DC output	Battery data status is abnormal. Battery gets into over-discharged protection	Read the battery information on the monitor.
3	The DC power supply time is too short	Battery capacity become smaller	Storage battery replacement or add more modules
4	The battery can't be fully charged to 100%	Charging voltage is too low	Adjust charging voltage at 57V
5	The power cable sparks once power on and ALM light RED	Power connection short-circuit	Turn off the battery, check the cause of the short circuit
6	Communication fault	The DIP setting of the host is wrong/ the battery type of the inverter is wrong/ Communication cable used incorrectly/The communication cable is incorrectly connected at the battery communication port or the inverter communication port/The battery firmware version is too low to support the inverter	Check these possible causes one by one

If you need any technical help or have any question, please contact the dealer in time.



Bluesun Solar Co., Ltd.

- +86 (158) 5821 3997
- +86 (551) 6565 2651
- info@bluesunpv.com
- www.bluesunpv.com